

# ajacovides

Andreas Jacovides Trading Ltd

## SIGNWRITERS TOOLS

## 2023

### 3M

Authorised Distributor  
Industrial Products

### SOTT

### OLFA

### NT Cutter

EVER NEW & EVER SHARP



**Andreas Jacovides Trading Ltd**

+357 22 866300 | Fax: +357 22 454843

sales@ajacovides.com | www.ajacovides.com

9 Imvrou, Industrial Area of Latsia | 2234 Nicosia, Cyprus  
P.O.Box 17047, 2260 Latsia | Nicosia, Cyprus



ISO 9001  
2015  
CERTIFIED COMPANY

f A. Jacovides Trading Ltd  
@ ajacovidestrading  
in Andreas Jacovides Trading Ltd

## SIGNWRITERS TOOLS



**AD Type 5 Blades**

Cartridge accommodates up to 5 of 30 degree tip blades

**NT Cutter**  
EVER NEW & EVER SHARP

**LION-NT-A-553P**

<b>A553P</b>	Light-Duty 30 degree blade (0.38) × 2
	49-04011-01019-4
Package: Blister pack Size (mm): 50×190×16 ■ 100 (10×10)	



30°  
AD type blade

**NT Cutter**  
EVER NEW & EVER SHARP

**LION-NT-AD-2P**

**PRO**  
Professional  
Professionally designed  
models

**AD Type**

Equipped with a 30 degree AD-type blade. Especially ideal for precision work.  
High-quality stainless steel holder.  
Designed for either left or right-handed use.  
Auto-lock (Ratchet-lock slider).  
A-type blade is also applicable.

Sturdy and light aluminum die-cast grip.  
Auto-lock (Ratchet-lock slider).



**NT Cutter**  
EVER NEW & EVER SHARP

**LION-NT-A-300GRP**

<b>A-300GRP</b>	Light-Duty blade (0.38) × 1
	49-04011-01076-7
Package: Blister pack Size (mm): 50×190×16 ■ 200 (20×10)	

Sturdy and light aluminum die-cast grip.  
Durable metal slider.  
Screw-locking system to hold blade securely.



**Heavy-Duty Models L**

<b>L-550GP</b>	Heavy-Duty blade (0.45) × 1	  
	49-04011-01087-3	
Package: Blister pack Size (mm): 75×215×27 ■ 100 (10×10)		

**NT Cutter**  
EVER NEW & EVER SHARP

**LION-NT-L-500GP**

Sturdy and light aluminum die-cast grip.  
Auto-lock (Ratchet-lock slider).



**Heavy-Duty Models L**

<b>L-500GR</b>	Heavy-Duty blade (0.45) × 1	  	<b>L-500GRP</b>	Heavy-Duty blade (0.45) × 1
	49-04011-01241-9			49-04011-01081-1
Package: Paper box Size (mm): 44×182×25 ■ 100 (10×10)		Package: Blister pack Size (mm): 75×215×27 ■ 100 (10×10)		

**NT Cutter**  
EVER NEW & EVER SHARP

**LION-NT-L-500GRP**

Extra large cutter with 0.7mm thickness blade.  
Non-slip comfortable grip. 5-assorted transparent colors.  
Screw-locking system to hold blade securely.  
Sturdy metal slider.



Thickness 0.7mm

<b>iX-500P</b>	Heavy-Duty extra-large blade (0.70) × 1	  
	49-04011-01170-2	
Package: Blister pack Size (mm): 75×215×27 ■ 100 (10×10)		

**NT Cutter**  
EVER NEW & EVER SHARP

**LION-NT-IX-500P**

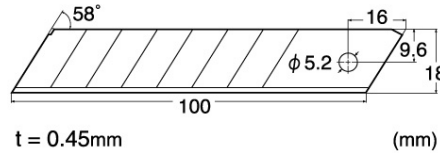

### LION-NT-BL-50P

Spare Blades 18mm 45 degree  
(50 pack)

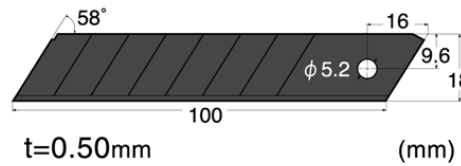

### LION-NT-BL51P

Spare Blades 18mm 45 degree Black  
(50 pack)

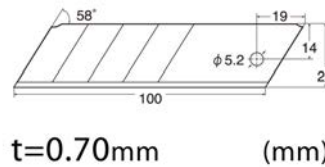

### LION-NT-BX-400P

NT SPARE BLADE 25MM 45 DEGREE  
(5 BLADES PER PACK)

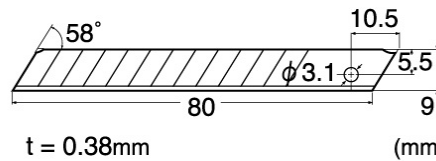

### LION-NT-BA-50P

Spare Blades 18mm 45 degree  
(50 pack)

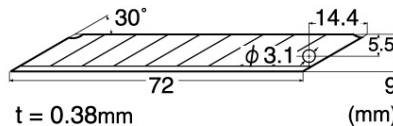

### LION-NT-BD-50P

Spare Blades 9mm 30 degree  
(50 pack)

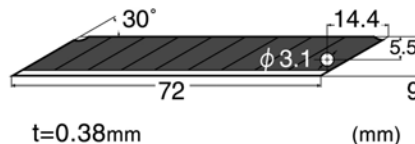

### LION-NT-BA15P

Spare Blades 9mm 30 degrees Black  
(10 pack)

### 120-LB series

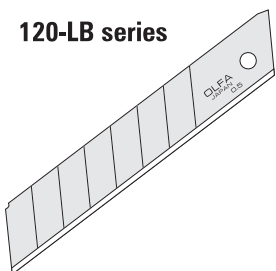

**OLFA**

OLFA 18mm Silver  
Snap-Off Blades

SOTT-120-LB-10

SOTT-120-LB-50

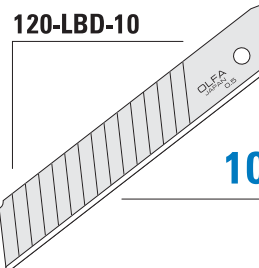

### 120-LBD-10

**OLFA**

OLFA 18mm Double segments  
heavy-duty Snap-off Blade

- 15 cutting edges per blade!

SOTT-120-LBD-10

Convenient craft cutter comes with a plastic cutting blade and a trimming blade. Trimming blade is ideal for making model, DIY and removing burrs on plastic.

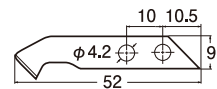
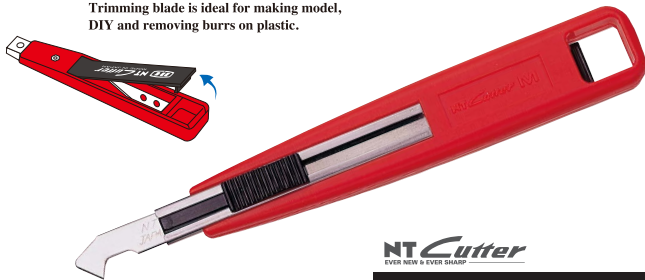

Plastic cutting blade (0.80)

**NT Cutter**  
EVER NEW & EVER SHARP

**LION-NT-M-500P**

**Spare Blades for M-500P**

**LION-NT-BM-2P 6 BLADES**



Example: PERFORMAX hand grip with squeegee



### SOTT-150-014 Handle

### PERFORMAX Hand Grip

**-130mm (5") wide**

Sturdy cast iron hand grip for use in conjunction with special soft squeegees. (see 'Soft Squeegees' section)

The Performax offers tremendous grip and allows extra pressure to be exerted on the squeegee during wet applications. Ideal for use on large areas of wet application such as self adhesive film on to acrylate and composite sheet materials, but especially suitable for window films and thick security film applications.

The Allen screws for attaching the squeegee are counter-sunk so they cannot damage your work.

Suitable for use with the following squeegees: **150-007, 150-012, 150-050**



Example: FUSION-8 hand grip with squeegee



### SOTT-150-043

### FUSION-8 Hand Grip

**-200mm (8") wide; indestructible plastic**

An exceptional hand grip, extra wide, manufactured from high quality, unbreakable plastic for use with special squeegees. FUSION hand grips offer an improved and extended grip reducing fatigue from squeegee work during those long applications. Extra comfort is provided by the anti-slip foam coating on the actual gripping area.

The curved form of this special smooth plastic hand grip prevents it from coming in to contact with film when extra pressure is applied, so any risk of damage to your work is eliminated. This is the ultimate hand grip for squeegees used for the wet application of film.

Perfect for use with thick and hard foils, such as security film and window film.

Also available in a narrower 13cm (5") version (**Fusion-5**).



Suitable for use with the following squeegees: **150-051**

**SOTT-150-051**

**The Orange Crush 200**

## SIGNWRITERS TOOLS



**SCRAPERITE®**

**SOTT-300-011**

**BIG GRIPPER SCRAPER**

price per piece

**- extra pressure and strength while scraping**

A solid addition to the Lil' Gripper range. The Big Gripper is perfect for heavy-duty jobs. It fits firmly in your hand, resulting in an improved strength on the surface. Now you know that even heavy-duty cleaning will go smoothly!



300-011 (Orange blade)

With orange blade



**SCRAPERITE®**

**SOTT-300-012**

price per set

**THE WIDE GRIPPER - 10cm (4")**

- extra wide
- strong plastic grip - will not break
- comfortable to hold
- with 1 or 5 blades

ADHESIVE and  
DIRT removal  
without  
causing any  
damage



*The*  
**WIDE** Gripper

The big brother of the Scraperite family. This 4" (10cm) wide scraper helps you tackle the toughest jobs by quickly removing adhesive residue, dirt, etc. from flat surfaces. The large polycarbonate scraper can be used on both sides and does not scratch surfaces. It's also easy to put in place and remove without fear of hurting yourself.

The Giant Gripper is entirely made of plastic, so it will never rust or oxidize. An indispensable tool for any signmaker, window tinter, painter or cleaner.

300-012 With 1 blade

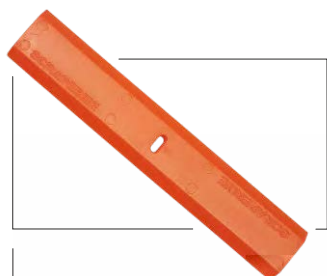

**SCRAPERITE®**

**SOTT-300-014**

**SCRAPER BLADE( For WIDE GRIPPER SCRAPER 300-012)**

**- 25 blades in box**

Polycarbonate scrapers for The Giant Gripper (300-012). Width 10cm (4")

price per package

300-014

## SIGNWRITERS TOOLS

### Scraper

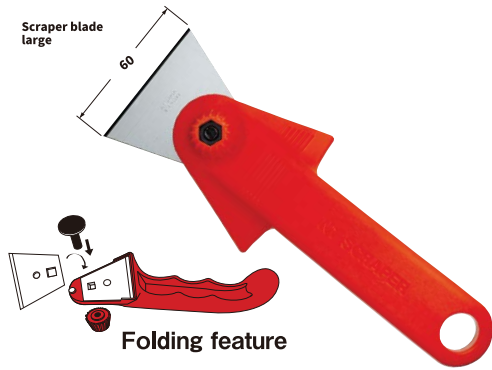

**NT Cutter**  
EVER NEW & EVER SHARP

**LION-NT-SC-2P**

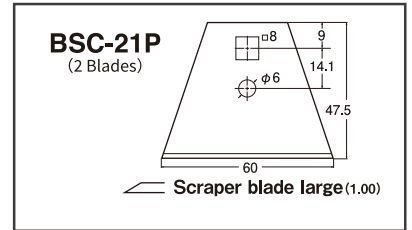

**BSC-21P**  
(2 Blades)

Scraper blade large (1.00)

Spare Blade for Scraper(2 blades)

**LION-NT-BSC-21P**

**OLFA**

**OLFA® XSR Extra Heavy Duty Scraper**

Extra heavy-duty scrapers for extra heavy-duty jobs

- 100mm(4") wide - In 3 different versions

300-050



**SOTT-300-050**

**OLFA EXTRA HEAVY DUTY SCRAPER - 200MM ARM**

300-051



**SOTT-300-051**

**OLFA EXTRA HEAVY DUTY SCRAPER - 300MM ARM**

300-052

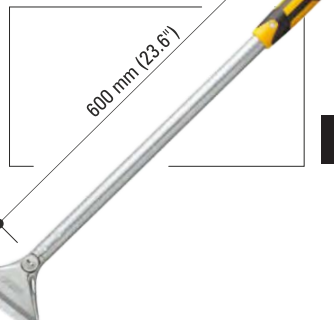

**SOTT-300-052**

**OLFA EXTRA HEAVY DUTY SCRAPER - 600MM ARM**



Recommended blades:

120-BS-10B

120-BS-08/6B,

120-BSF-6B

**TIP:** This scraper takes OLFA snap-off blades -type **120-LB10** too!



## SIGNWRITERS TOOLS

**OLFA**

120-BS-08/6b

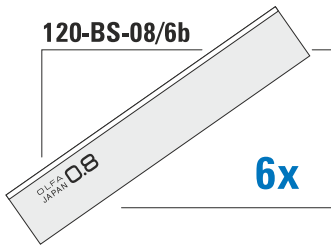

**SOTT-120-BS08/6B**

**OLFA® 100mm Scraper Blades -0.8mm thick, 6 pack**

Extra heavy duty and thick blade (.8mm) for OLFA scraper made of carbon tool. The blades fit all extra-heavy-duty XSR scrapers.

Specially for OLFA scrapers:  300-050, 300-051, 300-052

**OLFA**

120-BS-10B

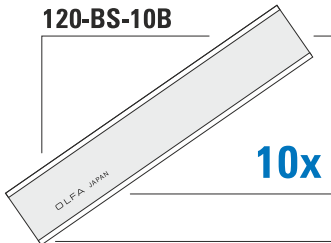

**SOTT-120-BS10B**

**OLFA® 100mm Dual-Edge Scraper Blades -10 pack**

Some jobs call for a sharp-edged scraper and some for a rough-edged scraper. These scraper blades give you both. All jobs call for a durable blade, and that's what you get with these carbon tool steel blades. The blades fit all extra-heavy-duty XSR and BSR scrapers.

Specially for OLFA scrapers:  300-050, 300-051, 300-052

**OLFA**

120-BSF-6B

6x

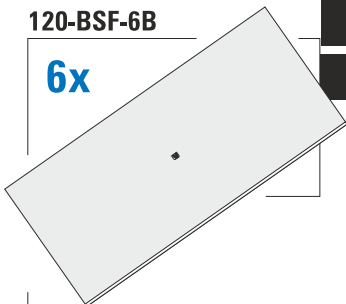

**SOTT-120-BSF-6B**

**OLFA® 100MM Flexible Dual-Edge Scraper Blades -0.45mm thick 6 pack**

Made of carbon tool steel for durability and designed with both a sharp and rough edged side. Thick (.45mm) but flexible blade allows for better leverage on difficult materials. 100mm flexible blade for all BSR and XSR Scrapers.

Specially for OLFA scrapers:  300-050, 300-051, 300-052

150-052



**DUNLOP**

**DUNLOP® SQUEEGEE**

**SOTT-150-052**

- entirely of plastic
- flexible but sturdy arm
- width 28cm (11")
- perfect for mounting etch films and window films on flat glass

Perfect squeegee for wet mounting of self-adhesive vinyl and window film on flat glass. The arm and handle are very sturdy and strong but the squeegee blade is quite flexible.

*Super Flexible*

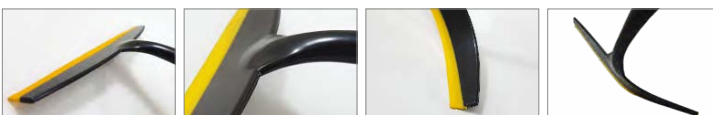

## SIGNWRITERS TOOLS

### LIL' GRIPPER



**300-006**  
+5 scrapers

### SCRAPERITE®

**SOTT-300-006**

**Lil' Gripper set with 5 extra scrapers**

- polycarbonate scrapers will not scratch the substrate!
- for use on glass, car paints, composite sheet material, etc.

For best results use:  
**Right-Off Adhesive remover**  
600-Z0415



### 300-009

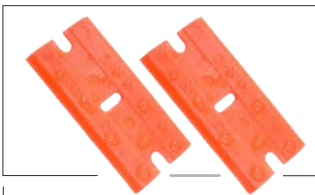

### SCRAPERITE®

**SOTT-300-009**

**SCRAPPER BLADE(300-006,300-011)**

**Orange scraper for Scrapperite holders -soft version**

- box of 100
- refill for Lil' Gripper 300-006 and Big Gripper 300-008

For use on the following substrates:

Acrylic, Brass, Ceramic Tile, Dishes, Glass, Formica, Hardwoods, Laminates, Mirror, Painted Surfaces, Polycarbonate, Vinyl Flooring, Windows.

### 300-009BL

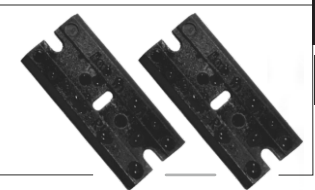

### SCRAPERITE®

**SOTT-300-009BL**

**BLACK SCRAPPER FOR SCRAPERITE HOLDERS-HARD**

**Black scraper for Scrapperite holders -hard version (polycarbonate)**

- box of 100
- refill for Lil' Gripper 300-006 and Big Gripper 300-008

This new tougher material is more resistant to breakage and wear. Designed for use in industrial and trade applications where repeated heavy use is common. Polycarbonate scrapers for the Lil' Gripper 300-006 and 300-008.

For use on the following substrates:

Aluminium, Brass, Ceramic Tile, Chrome, Glass, Fiberglass, Granite, Marble, Mirror, Stainless Steel, Windows.

### 350-210



**SOTT-350-210**

**SQUEEGEE SHARPENER (GRINDER)**

- is your squeegee burred?
- is your squeegee no longer straight and smooth due to wear and tear?

A squeegee often is a personal favorite and an applicator will always carry it with him. But what can you do when this particular squeegee has worn out so much, it's round and full of burrs? Keep it! Our Squeegee Sharpener is the solution to your problem! This smart tool has a small knife in its groove, fully smoothing the squeegee when pulled through. Smart and simple!



## SIGNWRITERS TOOLS



**SOTT-300-010**

**STRIP-IT EraserDisk**



**SOTT-300-010T**

**STRIP-IT EraserDisk**

**T-Series**

### -fast removal of film and stickers

Removing vinyl of a car can be a difficult and time consuming job. Especially when the vinyl is old and tears easily. Or what to think of removing reflective vinyl. The solution is the Strip-It EraserDisk. Mount it in a drill and off you go for a quick job! It will not damage the car paint.



**SOTT**

### WRAPEDGE

-for scratch free installations

<b>SOTT-500-037</b>	<b>WrapEdge-00</b>	0 mm sponge thickness
<b>SOTT-500-038</b>	<b>WrapEdge-01</b>	1 mm sponge thickness
<b>SOTT-500-039</b>	<b>WrapEdge-02</b>	2 mm sponge thickness
<b>SOTT-500-040</b>	<b>WrapEdge-03</b>	3 mm sponge thickness

**500-041**



**SOTT**

**SOTT-500-041**

### WRAPEDGE TRIAL PACK

A clean wrapping result is partly dependent on easy squeegeeing without scratching (!) The WrapEdge is made of alcantara and has a special moisture-absorbent sponge layer for wet work, for an even better result.



### EASYGRIP Holder for plastic squeegees

Do you ever have a fatigued wrist after squeezing films? Or do you sometimes lack the needed strength to really squeeze the films properly on large surfaces? Then the EasyGrip squeegee holder is perfect for you! Simply slide your standard plastic squeegee into this holder for improved grip. Available for 10cm and 13cm squeegees.

**150-024**

**150-025**

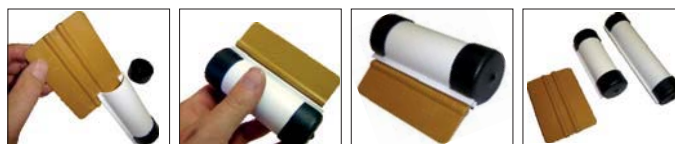

**SOTT-150-024** EasyGrip 10cm holder

**SOTT-150-025** EasyGrip 15cm holder

## SIGNWRITERS TOOLS

150-LM10



SOTT

**SOTT-150-LM10**

**SOTT Squeegee 10cm**

**-standard width**

The new OMEGA squeegee by SOTT unites all the features that a professional film installer can expect of a squeegee. Switching between different squeegees is no longer necessary.



**Stiff and sturdy**

*The OMEGA Squeegee by SOTT is made of a rubber/plastic composite that makes it stable and exerts good counter pressure when you are power squeegeeing.*

150-LM13



SOTT

**SOTT-150-LM13**

**SOTT Squeegee 13cm**

**Flexible and malleable**

*The OMEGA Squeegee follows all surface contours and curves impeccably.*



150-002

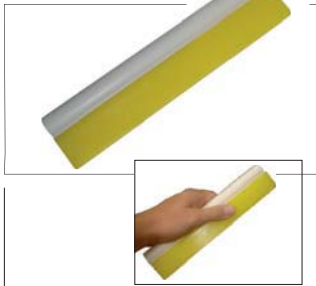

**SOTT-150-002**

**SOFTLINE TURBO SQUEEGEE 24cm**

Same type of squeegee as the 150-001, yet 24cm wide.



150-004

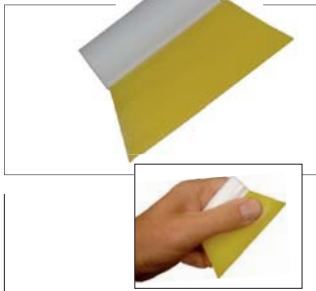

**SOTT-150-004**

**SOFTLINE TURBO SQUEEGEE 9cm**

Same type of squeegee as 150-001, 9 cm wide and specially shaped for squeezing in window frames and difficult corners.



150-030



**SOTT-150-030**

**DIAMOND TIP Yellow Squeegee**

An essential tool for applying vinyl in hard to reach areas, because of the special design and sharp edges of this squeegee. Won't scratch glass.

## SIGNWRITERS TOOLS

150-007



**SOTT-150-007**

**THE BLUE MAX (shaped)**

**-soft but resilient**

The Blue Max is the ultimate squeegee for wet applications, since no other squeegee can rival it for removing moisture under the film. Perfectly use for thick and stiff films, like safety films, solar windowfilms and laminated digital print films.

150-016

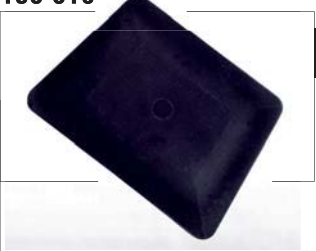

**SOTT-150-016**

**Teflon Black -Flexi soft**

**-Flexi and soft**

**-Heat resistant**

The BLACK "TEFLON" HARD CARD is second to the White hard card in popularity. This card provides a little more flexibility than the WHITE or the GOLD, but it is stiffer than the BLUE which makes it great for both flat and curved glass surfaces.

150-035



**SOTT-150-035**

**5-WAY TOOL**

Tough Plastic ruler for easily cutting window film in edges and corners. Because of the unique design it is possible to cut in different angles. Designed for applying vinyl and window films on flat glass.

150-041



**SOTT-150-041**

**FELT SQUEEGEE**

**-standard quality**

Perfect to use for CarWrapping and applications of vinyls and films without application tape. Won't scratch the vinyl.

**PROTECTIVE FELT -wool**

**SOTT**

**PROTECTIVE -2mm**

**-self adhesive; will not come loose when wet**

**-available in two widths**



500-018: 10cm wide  
500-019: 13cm wide

**500-019** Width: 13cm

**500-018** Width: 10cm

## SIGNWRITERS TOOLS

### PROTECTIVE VELOURS

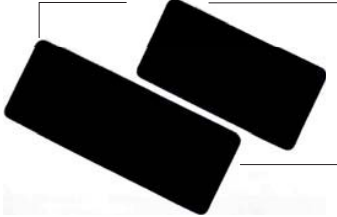

**SOTT**

### PROTECTIVE VELOURS -1mm

- self adhesive; stays in place
- specially intended for car wrap films and soft cast film applications

**SOTT-500-045** Width: 10cm

**SOTT-500-046** Width: 13cm

500-045: 10cm wide  
500-046: 13cm wide

### 150-034



**SOTT-150-034**

**THE CHIZLER SQUEEGEE**

Bigger than his little brother shown above. Will not damage defrost liners on the rear window.

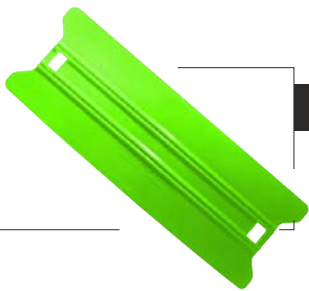

**SOTT-150-077**

**SpeedWing Lime 21cm -Hard**

- one side flat
- one side curved

The curved edge is designed to encourage a finger or bubble to disperse outward which reduces the chances of a crease.

**SOTT-150-088**

**SOTT THE SQUAD - SET OF 2 INCL. FACTOTUM & CRAWLER**

**THE SQUAD**



## SIGNWRITERS TOOLS

SOTT-150-MM882

SOTT Mounting magnet



SOTT-150-MM883

SOTT The Goliath magnet



**EXTRA STRONG: MORE THAN 24kg OF PULL!**



**3M**

**3M-FINISH-LINE/3.5 3M KNIFELESS FINISH LINE TAPE 3.5MM X50M**



For finishing vehicle graphic installations without a blade. Designed to protect the substrate from blade damage.



**3M**

**3M-DESIGN-LINE/3.5 3M KNIFELESS DESIGN LINE TAPE 3.5MM X50M**



For finishing vehicle graphic installations without a blade. Designed to protect the substrate from blade damage. Stretches slightly and turns easily in any direction.



# SIGNWRITERS TOOLS

## Safety Straight Edges

**KEENCUT**



### Designed for your safety

You can rely on Keencut's industry-leading reputation for safety and quality, even when buying the simplest tool. Our lightweight Safety Straight Edge is precision engineered for use in marking, drawing, pen-lining, scoring or cutting.



**KEEN-MS120** Safety Straight Edge Metric 120cm

**KEEN-MS150** Safety Straight Edge Metric 150cm

## SIGNWRITERS TOOLS

500-020



**SOTT-500-020**

**SPEEDCLIP**

**-no more unsightly curled up pieces of tape**

It's always been a problem: securing your rolls of film after use. Usually they are just taped up, but this often means that when the tape is removed the film gets damaged. Not anymore!

**Flexible and self-closing**



**Can be used on thick rolls**



300-023



Roll length: 36m (62 sheets)

**SOTT-300-023**

**- removes all dust from any surface**  
**- leaves no residue**

Slightly adhesive wipe on a roll. Ideal for removing all dust from any surfaces to be worked on. Removes dust from prints before laminating. Removes dust from windows and bodywork prior to film application. Removes dust from metal surfaces before painting or spraying. The roll is 30cm (1'2") wide and each roll consists of individual sheets that can be pulled off as required. One side is slightly adhesive. Leaves no residue.

CODE	DESCRIPTION	PER PIECE
ANSELL-76-200 SIZE: 9	76-200-Light weight nylon. Spandex wrist elastic. Length 190-235 mm (7-9 inch). White	

**EDGE**<sup>®</sup>  
INDUSTRIAL WORK GLOVES

**76-200**

Soft and comfortable seamless glove for longer and more comfortable wear



NYLON

CODE	DESCRIPTION	PER PIECE
ANSELL-76-100 SIZE: 9	76-100-Light weight cotton. Length 215-235 mm (8-9 inch). Natural Colour	

**EDGE**<sup>®</sup>  
INDUSTRIAL WORK GLOVES

**76-100**

Light, stretchy gloves available in various materials and finishes



COTTON

## SIGNWRITERS TOOLS

600-AA1400-100



100ml

Eliminate  
RISKS  
by improving  
ADHESION

**SOTT**

Bonding primer for water based car lacquers

**SOTT-150-088**

**ADHESIVE ACTIVATOR -100ml**

- neutralises surfaces containing silicone
- harmless to the substrate

Always a pain: film that releases out of recesses and channels. This could be for a number of reasons, but one of the main causes is the actual car paint.

Damaged film at the edges



Poor adhesion of full-colour prints



The risks involved with water-based car lacquers:

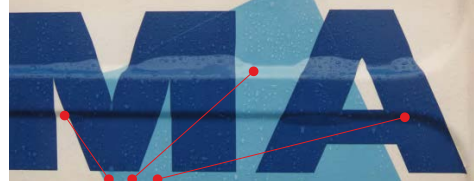

Due to the silicone content in modern car lacquers the adhesion of film can be far from optimal. Film under tension (especially in recesses) is bound to come loose and ultimately be returned for repair or renewal.



600-GC101



**SOTT**

For large glass areas and windows in buildings

**SOTT-600-GC101FLES**

**Industrial Glass Cleaner - 1 Liter Bottle**

- for optimal cleaning and degreasing of glass to prepare it for the mounting of tinting film
- with a fresh and pleasant odour; no lingering nasty smells
- deep-cleans and dries fast without leaving stripes.



600-SC02



**SOTT**

Professional cleaner before film application

**SURFACE CLEANER-II**



- developed especially for the sign industry
- cleans car paint, metal, plastic, glass, bisonyl, etc, etc.
- biologically degradable

Trigger sprayer  
each

**SOTT-600-SCIIFLES**

1ltr bottle-with trigger

Jerrycan  
contains 5 liter

**SOTT-600-SCIICAN**

5ltr Jerrycan

600-T800



**SOTT**

**SOTT-600-T800FLES**

**Industrial Super Degreaser - 1 Liter Bottle**

- harmless for car paints
- removes silicone, grease, tar, oil, adhesive, paraffin and car importer's wax

A unique balanced product that was especially commissioned and developed some 20 years ago for use in the metal fabrication, automotive and advertising industries. Used extensively in the metal fabrication industry for degreasing prior to chroming or galvanizing SO THIS IS A REAL DEGREASER!





## SIGNWRITERS TOOLS

500-050



**SOTT-500-050**

**ROLL DISPENSER**

**- indispensable in every workshop**

Metal dispenser for rolls of triple layer polishing paper (300-040). This handy dispenser holds a roll of polishing paper and allows individual sheets to be torn off across a black perforated guide at the top. The dispenser can be folded for easy transportation.

*Suitable for:*  
**Rolls of Triple layer polishing paper 300-040**



300-040



**SOTT-300-040**

**POLISHING PAPER TRIPLE LAYER 2 ROLLS**

**- 2 rolls -37cm (1'3") wide**

Industrial grade triple layer highly absorbent polishing paper. This paper is extremely strong and will not disintegrate when saturated with water. Soft but strong. Indispensable in every workshop.

*Useable for:*  
**Roll dispenser 500-050**

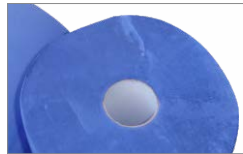

*This high quality compactly rolled polishing paper is extremely soft and so will not scratch the substrate.*

550-110



**SOTT-550-110**

**THE SPRAYMASTER**

**- is not affected by chemicals, degreasers, cleaners, adhesive removers, acids or aggressive liquids!**

You've never seen a sprayer like this! The Spray Master releases a powerful mist instead of just beads of moisture. With a range of **up to 3 metres!** The Spray Master has an enormous spread of spray and covers the entire surface with a 'cloud'. This mist is much finer than the beads of moisture normally associated with other sprayers. The turbulent spraying action not only ensures that the surface is more efficiently sprayed, but the resulting mist also 'pulls' any dust that happens to be swirling around out of the ambient air.

550-200



26cm

**SOTT**

**SOTT-550-200**

**TRIGGER**

**The Trigger spray head for 1 liter bottles**

## SIGNWRITERS TOOLS

600-T900



**SOTT-600-T900**

**Siliconen/Wax Remover - 1000ml**

Applying vinyl on a surface that is treated with auto wax like Meguiar's or other brands, can be a nuisance. The protective layer usually rejects the adhesive, which could result in less-than-pleasant phone calls from your customer. In this case use T-900. This strong silicone remover will dissolve the wax and degrease the surface for a perfect application job.

600-TRL1000



**SOTT**

**SOTT-600-TRL1000CAN**

**Film Remover - 5 Liter Bottle**

**SOTT-600-TRL1000FLES**

**Film Remover - 1 Liter Bottle**

**-Removes self adhesive film from car paintwork, Beauty Board, glass and metal**

Suitable for use on car paintwork, Beauty Board, and metal. Works with cast, polymeric and monomeric film. Not suitable for use with reflective film and on soft substrates such as rigid foam, banners, awnings, acrylate, etc.

*Read the instructions on the packaging carefully*

600-TO



**SOTT-600-TO**

**Tint-Off Windowfilm Remover - 1000ml**



Removing film from car windows can pose quite a problem. Tint-Off has been developed especially for this purpose. Apply this soluble remover to the existing film, cover with a piece of old film or liner. After a few minutes, remove the piece of old film or liner and the old window film will be released with it.

*Read the instructions on the packaging carefully*

600-Z0415



**SOTT**

The one and only real adhesive remover is renewed!

**RIGHT-OFF**

**-removes adhesive residue in 2 minutes  
-also removes tar, grease, chewing gum, paint, etc.  
-harmless to all substrates**



**SOTT-600-Z0415FLES**

**Right-Off Adhesive Remover - 1 Liter Bottle**

**SOTT-600-Z0415CAN**

**Right-Off Adhesive Remover - 5 Liter Jerrycan**



Authorised Distributor  
Industrial Products

## SIGNWRITERS TOOLS



**ΧΡΥΣΕΣ ΣΠΑΤΟΥΛΕΣ** - Gold Applicator

10cm

**ΜΠΛΕ ΣΠΑΤΟΥΛΕΣ** - Blue Applicator

10cm

**ΦΑΚΕΛΟΙ ΓΙΑ ΣΠΑΤΟΥΛΕΣ** - Sleeves

10cm

**ΦΑΚΕΛΟΙ ΑΠΟ ΤΣΟΧΑ** (MANCHET FILT)

10cm



**COMPLY ΣΠΑΤΟΥΛΕΣ** (CPA-1)

19cm



**ΒΟΥΡΤΣΑΚΙΑ** (RIVER BRUSH APPLICATOR)



**ΜΑΧΑΙΡΙ ΜΑΤΟΡ-SWITTY**



**ΣΥΣΤΗΜΑ ΑΦΑΙΡΕΣΗΣ ΓΡΑΦΙΚΟΥ**  
GRAPHIC REMOVER SYSTEM

1 Liter



**ΣΥΣΤΗΜΑ ΑΦΑΙΡΕΣΗΣ ΓΚΡΑΦΙΤΙ**  
GRAFFITI REMOVER

1 Liter



**ΣΥΣΤΗΜΑ ΕΤΟΙΜΑΣΙΑΣ ΕΠΙΦΑΝΕΙΑΣ**  
SURFACE PREPARATION SYSTEM

5 Liter



Authorised Distributor  
Industrial Products

## SIGNWRITERS TOOLS



**ΚΑΘΑΡΙΣΤΙΚΟ ΜΕΜΒΡΑΝΩΝ**  
FILM CLEANER

5 Liter



**ΜΟΝΩΤΙΚΟ 3950**  
EDGE SEALER

0,237 Liter



**8984 ADHESIVE REMOVER**

1 Liter



**INDUSTRIAL CLEANER UK 9472**  
Adhesive Remover

500ml



**N 94 PRIMER**

250ml



**GLASS PRIMER**

1 Liter



Authorised Distributor  
Industrial Products

## SIGNWRITERS TOOLS



**DP8405 EPOXIC GLUE**  
BEIGE

45ml

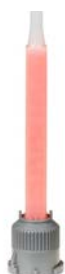

**3M-SW-EPX**  
ΑΚΡΟΦΥΣΙΟ ΑΝΑΜΙΞΗΣ

45ml



**3M-EPX**  
ΠΙΣΤΟΛΙ ΧΕΙΡΟΣ



**3M-EPX ΠΡΟΩΘΗΤΗΡΑΣ 10:1**



**ΠΙΣΤΟΛΙ ΧΕΙΡΟΣ ΓΙΑ 3738-Q JEL MELT**



**3738-Q JEL MELT**  
ΓΙΑ ΠΙΣΤΟΛΙ ΧΕΙΡΟΣ (ΚΙΒΩΤΙΟ)



Authorised Distributor  
Industrial Products

## SIGNWRITERS TOOLS



### 3M201E/18MM

201E Masking Tape 18mm x 50m 48R/48C 80 C

18mm x 50m



### 3M201E/24MM

201E Masking Tape 24mm x 50m 36R/48C 80 C

24mm x 50m



### 3M201E/48MM

201E Masking Tape 48mm x 50m 24R/48C 80 C

48mm x 50m



### 309/48

309 TAPE 48mmX66m BROWN

48mm x 66m



### 309/48-CLEAR

309 TAPE 48mmX66m CLEAR

48mm x 66m



### DUAL LOCK SJ 4570 CLEAR

48mm x 66m

Σύστημα Στερέωσης χαμηλού προφίλ από πολυολεφίνη, με το μισό πάχος των τυπικών Dual Lock™ Επανακλειόμενων Συστημάτων Στερέωσης και δυνατότητα να συνδέεται στον εαυτό του. Ανοίγει και κλείνει 100 φορές.



### SJ5302A

SJ 5302A CLEAR BUMPONS

8mm x 2,3mm



### SJ5312

SJ 5312 CLEAR BUMPONS

8mm x 3,5mm

3M™ Bumpon™ Protective Product is a self-adhesive rubber bumper designed to be used as feet, stops and spacers. The hemispherical shape provides excellent sound damping and energy absorption.



Authorised Distributor  
Industrial Products

## SIGNWRITERS TOOLS



**4026/12-33MTRS**  
4026 SCOTCH MOUNT 12MM X 33M

12mm x 33m  
Thickness 1,5mm

**4026/19-33MTRS**  
4026 SCOTCH MOUNT 19MM X 33M

19mm x 33m  
Thickness 1,5mm

General interior and exterior mounting applications where the tape will be protected from the environment



**9508W/12**  
9508 SCOTCH MOUNT 12mmX66m WHITE

12mm x 66m  
Thickness 0,8mm

**9508W/19**  
9508 SCOTCH MOUNT 19mmX66m WHITE

19mm x 66m  
Thickness 0,8mm

3M™ Double Coated Foam Tape 9508 is a white, 0.8mm thick, double coated closed-cell polyethylene foam tape with acrylic adhesive. The acrylic adhesive provides good initial tack and adhesion to a wide variety of surfaces.

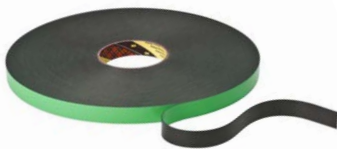

**9508BF/3.5MM**  
9508BF SCOTCH MOUNT 3.5mmX66m BLACK

3,5mm x 66m  
Thickness 0,8mm

**9508BF/12MM**  
9508BF SCOTCH MOUNT 12mmX66m BLACK

12mm x 66m  
Thickness 0,8mm

Black, 0.8 mm thick, closed-cell double coated polyethylene foam with acrylic adhesive



**4941/12**  
4941 VHB TAPE 12MM X 33M GREY

12mm x 33m  
Thickness 1,1mm

**4941/19**  
4941 VHB TAPE 19MM X 33M GREY

19mm x 33m  
Thickness 1,1mm

Our 3M™ VHB™ Tape consists of a durable acrylic adhesive with viscoelastic properties. This provides an extraordinarily strong double sided foam tape that adheres to a broad range of substrates, including aluminum, stainless steel, galvanized steel, composites, plastics, acrylic, polycarbonate, ABS and painted or sealed wood and concrete.



**4611/12**  
4611 VHB TAPE 12MM X 33M GREY

12mm x 33m  
Thickness 1,1mm

**4611/19**  
4611 VHB TAPE 19MM X 33M GREY

19mm x 33m  
Thickness 1,1mm

Dark gray, 0.045 in (1.1 mil), general purpose adhesive with firm foam has added feature of high temperature resistance. Can be used indoors or outdoors in a variety of applications, including window, door and sign assembly, electronics, construction and countless other industrial applications.



**3M-GPH-060GF/12**  
GPH-060GF VHB TAPE 12MM X 33M GREY

12mm x 33m  
Thickness 0.6mm

**3M-GPH-110GF/12**  
GPH-110GF VHB TAPE 12MM X 33M GREY

12mm x 33m  
Thickness 1,1mm

Our 3M™ VHB™ Tape consists of a durable acrylic adhesive with viscoelastic properties. This provides an extraordinarily strong double sided foam tape that adheres to a broad range of substrates, including aluminum, stainless steel, galvanized steel, composites, plastics, acrylic, polycarbonate, ABS and painted or sealed wood and concrete.



Authorised Distributor  
Industrial Products

## SIGNWRITERS TOOLS



### 4614/6

4614 VHB TAPE 6MMX33M CLEAR

6mm x 33m  
Thickness 1,1mm

### 4614/9/66

4614 VHB TAPE 9MMX66M CLEAR

9mm x 33m  
Thickness 1,1mm

### 4614/12/33

4614F VHB TAPE 12MMX33M CLEAR

12mm x 33m  
Thickness 1,1mm

It is a clear, 0.8 mm thick, general purpose acrylic adhesive on both sides of a firm, foam core. It can replace rivets, welds and screws.



### 4915/6

4915 VHB 6MMX25M CLEAR

6mm x 25m  
Thickness 1,5mm

### 4918/6

TAPE VHB 4918 6MMX16.5M CLEAR

6mm x 16,5m  
Thickness 2mm

### 4918/9

TAPE VHB 4918 9MMX16.5M CLEAR

9mm x 16,5m  
Thickness 1,5mm

Transparent, 1.5 mm, general purpose acrylic adhesive and firm acrylic foam core. Strong and durable bonds to a wide variety of high to medium surface energy substrates like paints, metals and glass, acryl glass (PMMA), polycarbonate.

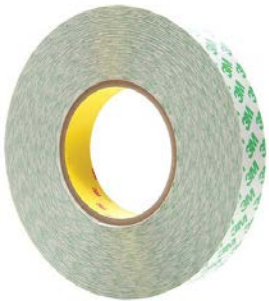

### 9087/12

9087 HPDC PVC KRAFT 12MMx50M WHITE

12mm x 50m  
Thickness 0,265mm

### 9087/25

9087 HPDC PVC KRAFT 25MMx50M WHITE

25mm x 50m  
Thickness 0,265mm

### 9087/50

9087 HPDC PVC KRAFT 50MMx50M WHITE

50mm x 50m  
Thickness 0,265mm

Acrylic adhesive bonds to many high and low surface energy substrates. Thick adhesive bonds to rough surfaces



### 020F/CLEARTAPE/06MM

020F 6MM x 50M CLEAR FILM TAPE

6mm x 50m  
Thickness 0,265mm

### 020F/CLEARTAPE/09MM

020F 9MM x 50M CLEAR FILM TAPE

9mm x 50m  
Thickness 0,265mm

### 020F/CLEARTAPE/12MM

020F 12MM x 50M CLEAR FILM TAPE

12mm x 50m  
Thickness 0,265mm

### 020F/CLEARTAPE/25MM

020F 25MM x 50M CLEAR FILM TAPE

25mm x 50m  
Thickness 0,265mm

### 020F/CLEARTAPE/50MM

020F 50MM x 50M CLEAR FILM TAPE

50mm x 50m  
Thickness 0,265mm

3M™ High Performance Double Coated Tape 9088-200 is designed as a go-to industrial tape for long term adhesion in a very broad range of applications where a thicker tape is desired.

### 9576-BLACK/4MM

9576B 4MM X50M BLACK

4mm x 50m





Authorised Distributor  
Industrial Products

## SIGNWRITERS TOOLS



**ABI-TR592U** TransferRite 592U Paper Transfer film 1.22x100m



**ABI-TR1750** TransferRite 1750 Plastic Transfer film 1.22x100m



**SCPS-100** Paper Transfer Film SCPS-100/1.22x91.4m



**SCPS-101** Plastic Transfer Film SCPS-101/1.22x100m

## Accurate safe cutting anywhere

Remove the safety risk of using a hand knife by adding the lightweight Simplex to your tool kit.

Ideal in the workshop or on-site, for use by the craftsman or fitter, the Simplex offers precision cutting accuracy in any environment.

It will tackle a wide variety of materials from PVC foamboard to floor coverings and its superior build quality and robust design makes it the perfect portable unit.

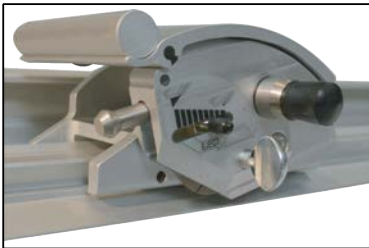

## Materials cut

### Semi-rigid materials

- PVC foamboard 6mm
- Corrugated/fluted plastic 10mm
- Corrugated cardboard 10mm
- Foam centred board 10mm

### Rigid materials (scoring only)

- Cast acrylic / Plexiglas 3mm, using SCO scoring blades

### Flexible materials

- Banners
- Magnetic sheet
- Film
- Self-adhesive vinyl
- Textiles and delicate materials, with optional fabric cutter attachment

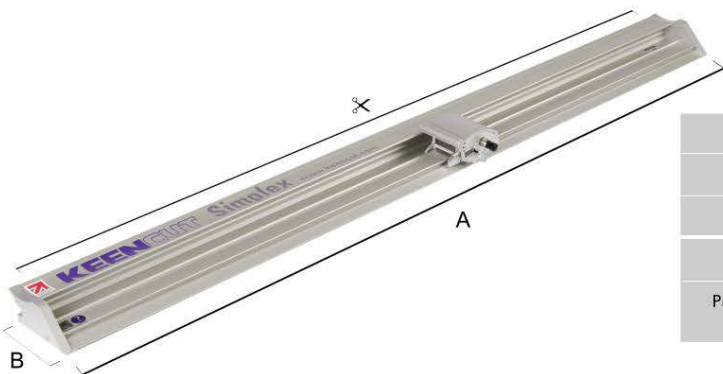

	CODE	CODE	CODE	CODE	CODE
	SIM110	SIM160	SIM210	SIM260	SIM310
✂ Cut Length cm (")	110 (44)	160 (64)	210 (84)	260 (104)	310 (124)
A cm (")	127 (50)	177 (70.75)	227 (89.5)	277 (109.25)	327 (128.75)
B cm (")	11 (4.4)	11 (4.4)	11 (4.4)	11 (4.4)	11 (4.4)
Packed Weight KG (lbs)	4 (9)	6 (13)	7 (15)	21 (46)	26 (57)
Packed Dimensions cm (")	139x17x16 (55x7x6)	190x17x16 (75x7x6)	237x17x16 (93x7x6)	289x20x17 (114x8x7)	338x20x17 (133x8x7)

CODE	Simplex accessories, blades & consumables
TEXC	28mm Textile Cutting Tool
CA50-019	Medium Duty Blades (Box of 100)
SCO	Scoring Blades for acrylic (Pack of 5)
TEXB	28mm Circular Textile Blades (Pack of 10)
SILYT	Yellow 'T' shape silicone cord 10m (33ft)



Simple to use



Total stability

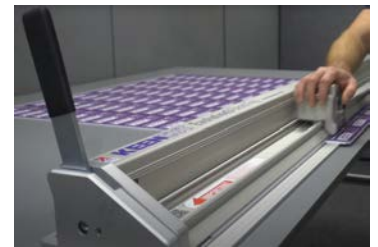

Heavy duty reliability



## Materials cut

### Semi-rigid materials

- Corrugated cardboard 13mm
- PVC foamboard 13mm
- Corrugated plastic 13mm
- Foam centred board 13mm

### Rigid materials

- Cast acrylic / Plexiglas 3mm scoring only
- Aluminium composite panel, e.g. DiBond 3mm
- Rocker tool head only, for occasional use

### Flexible materials

- Banners
- Pop-ups
- Magnetic sheets
- Film
- Self-adhesive vinyls
- Textiles
- Delicate materials: tissue paper, wallpaper

Evolution3 BenchTop cutters	
E3BT110	Evolution3 BenchTop 110 - 1.1m - 44"
E3BT160	Evolution3 BenchTop 160 - 1.6m - 64"
E3BT210	Evolution3 BenchTop 210 - 2.1m - 84"
E3BT260	Evolution3 BenchTop 260 - 2.6m - 104"
E3BT310	Evolution3 BenchTop 310 - 3.1m - 124"
E3BT360	Evolution3 BenchTop 360 - 3.6m - 144"

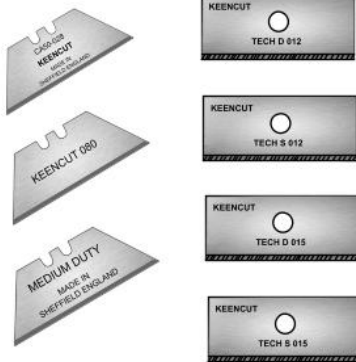

CODE	Evolution3 tool heads
E3T-CRE	Creaser tool head for Evolution3
E3T-FAB	Fabric tool head for Evolution3
E3T-GR2	Double Graphik tool head for Evolution3
E3T-ROC	Rocker tool head for Evolution3

CODE	Evolution3 blades & consumables
SLS	Sightline strips 5.5m (18ft)
EVOTCS	Textile Cutting Strip for Evolution3 SmartFold, 2 x 4.5m (2 x 15ft)
SILYT	Yellow 'T' shape silicone cord 10m (33ft)
SILYR	Yellow round shape silicone cord 10m (33ft)
CA50-019	Medium Duty Blades (Box of 100)
CA50-017	Tech D .012 Blades (Box of 100)
CA50-032	Graphik Blades (Box of 100)
CA50-010	Superior Quality 080 Blades (box of 100)
CIR45	Olfa 45mm Circular Textile Blade (Pack of 10)

CODE	Blades & consumables for discontinued products
CA50-019	Medium Duty Blades (Box of 100)
CA50-032	Graphik Blades (Box of 100)

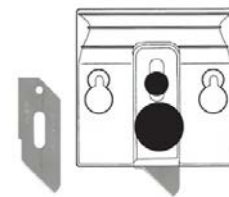



CODE		SteelTrak cutters
ST165		SteelTrak 165cm - 65"
ST210		SteelTrak 210cm - 82"
ST250		SteelTrak 250cm - 98"
CODE		SteelTrak free-standing kits
FSK160		Free-standing kit for SteelTrak 165 or Excalibur 5000 160cm
FSK210		Free-standing kit for SteelTrak 210cm - 82"
FSK250		Free-standing kit for SteelTrak 210cm - 98"
CODE		SteelTrak tool heads
STC2C		Steel and aluminium composite cutting head for SteelTrak
STALC		Aluminium twin wheel cutting head for SteelTrak
STSTC		Steel plate cutting head for SteelTrak
STGLC		Glass cutting kit for SteelTrak
STVG2		2mm V-Groove cutting tool for SteelTrak
STVG3		3mm V-Groove cutting tool for SteelTrak
STVG4		4mm V-Groove cutting tool for SteelTrak
STVG5		5mm V-Groove cutting tool for SteelTrak
STVG6		6mm V-Groove cutting tool for SteelTrak
CODE		SteelTrak accessories, blades & consumables
STSAE		Left hand squaring arm extension - 700mm (27.5") for SteelTrak
SLS		Sightline strips 5.5m (18ft)
SILYT		Yellow 'T' shape silicone cord 10m (33ft)
CA50-015		Tungsten Carbide Glass Cutting Wheel (each) minimum order 5 units
CA50-019		Medium Duty Blades (Box of 100)
STVGB		V-Groove Replacement Blade for SteelTrak (x 5)
STALW		Aluminium twin wheel cutter blade set for SteelTrak
STCOW		Composite twin wheel cutter blade set for SteelTrak
STSTW		Steel plate cutting wheels for SteelTrak

**SIGNWRITERS TOOLS**  
**CATALOGUE**

**2023**

**Andreas Jacovides Trading Ltd**

+357 22 866300 | Fax: +357 22 454843  
sales@ajacovides.com [www.ajacovides.com](http://www.ajacovides.com)  
9 Imvrou, Industrial Area of Latsia | 2234 Nicosia, Cyprus  
P.O.Box 17047, 2260 Latsia | Nicosia, Cyprus



A. Jacovides Trading Ltd  
 ajacovidestrading  
 Andreas Jacovides Trading Ltd