

ajacovides

Andreas Jacovides Trading Ltd

Display Stands Accessories

Κατάλογος Προϊόντων 2023



*ΛΟΓΩ ΤΗΣ ΣΥΝΕΧΟΥΣ ΑΥΞΟΜΕΙΩΣΗΣ ΤΩΝ ΠΡΩΤΩΝ ΥΛΩΝ, ΤΗΣ ΕΝΕΡΓΕΙΑΣ ΚΑΙ ΤΩΝ ΜΕΤΑΦΟΡΙΚΩΝ ΟΙ ΤΙΜΕΣ ΤΩΝ ΠΡΟΪΟΝΤΩΝ ΕΝΔΕΧΕΤΑΙ ΝΑ ΑΛΛΑΞΟΥΝ ΧΩΡΙΣ ΠΡΟΕΙΔΟΠΟΙΗΣΗ. ΠΑΡΑΚΑΛΟΥΜΕ ΟΠΩΣ ΕΠΙΚΟΙΝΩΝΕΙΤΕ ΜΕ ΤΟΝ ΑΡΜΟΔΙΟ ΠΩΛΗΤΗ Η ΤΑ ΓΡΑΦΕΙΑ ΜΑΣ ΓΙΑ ΕΠΙΒΕΒΑΙΩΣΗ.

+357 22 866300 | Fax: +357 22 454843 @ customerservice@ajacovides.com



9 Imvrou, Industrial Area of Latsia| 2234 Nicosia, Cyprus| P.O.Box 17047, 2260 Latsia| Nicosia, Cyprus

A. Jacovides Trading Ltd @ ajacovidestrading in Andreas Jacovides Trading Ltd

Andreas Jacovides Trading Ltd







Code:	DH-ECO-ROTI/80
Desc:	ROLL-UP ECO ROTI 80X200cm
	Graphic Dimensions: 80 x 200cm
	Weight: 2 kg

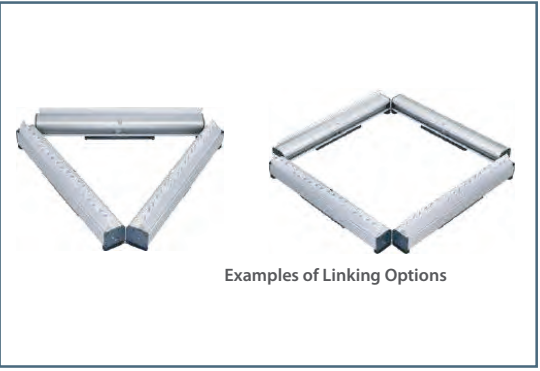

Code:	DH-KAKA
Desc:	KAKA FOR ROLL UP
	

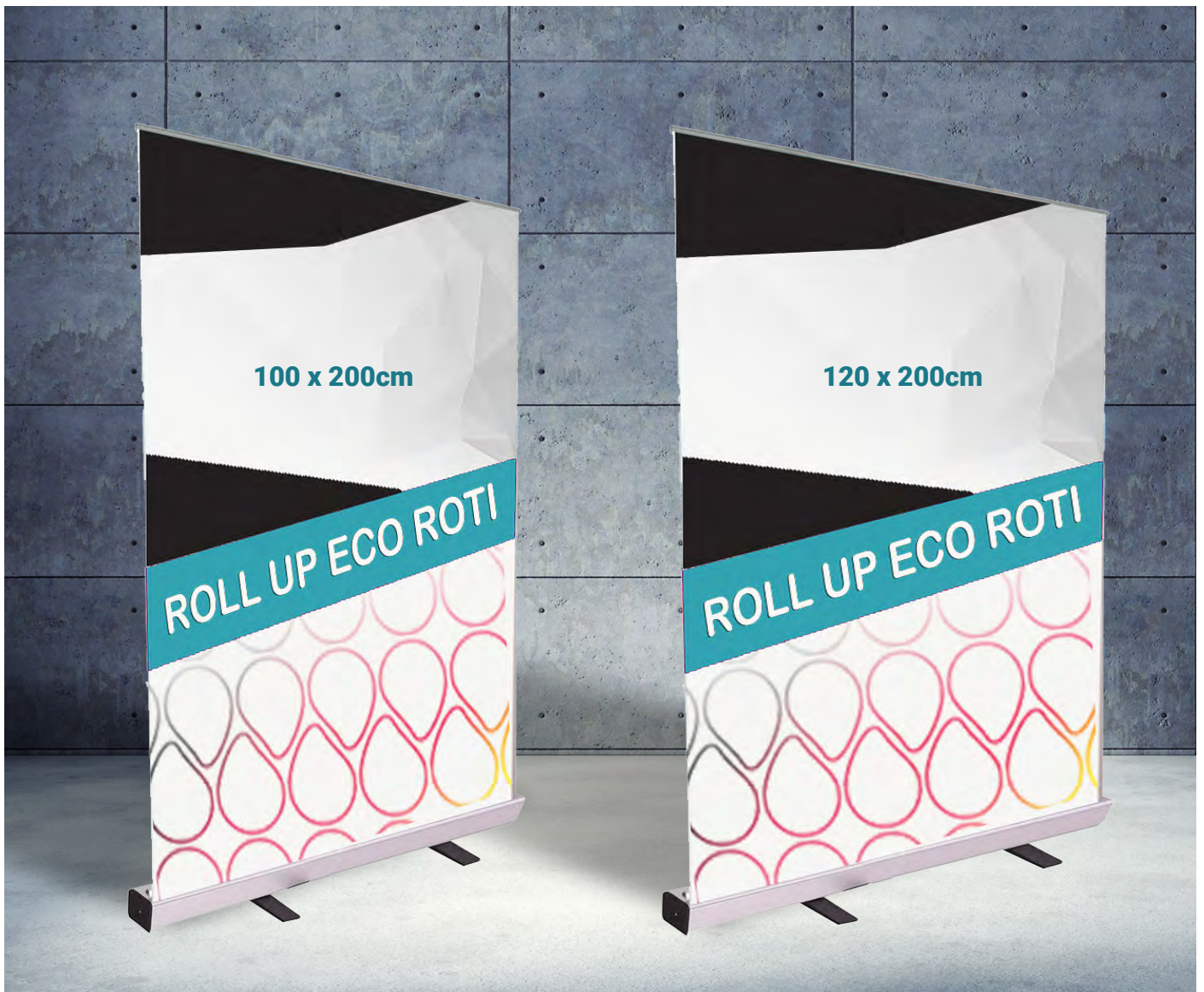
Code:	DH-ANGLE-LINK
Desc:	ANGLE LINK FOR ROLL UP
	







Code:	DH-ECO-ROTI/100
Desc:	ROLL-UP ECO ROTI 100X200cm
	Graphic Dimensions: 100 x 200cm
	Weight: 3 kg

Code:	DH-ECO-ROTI/120
Desc:	ROLL-UP ECO ROTI 120X200cm
	Graphic Dimensions: 120 x 200cm
	Weight: 3.8 kg







Code:	DH-BASIC/150
Desc:	ROLL UP DH-BASIC 150X200CM
	Graphic Dimensions: 150 x 200cm
	Weight: 3,8 kg







Code:	DH-BASIC/200
Desc:	ROLL UP DH-BASIC 200X200CM
	Graphic Dimensions: 200 x 200cm
	Weight: 4,8 kg

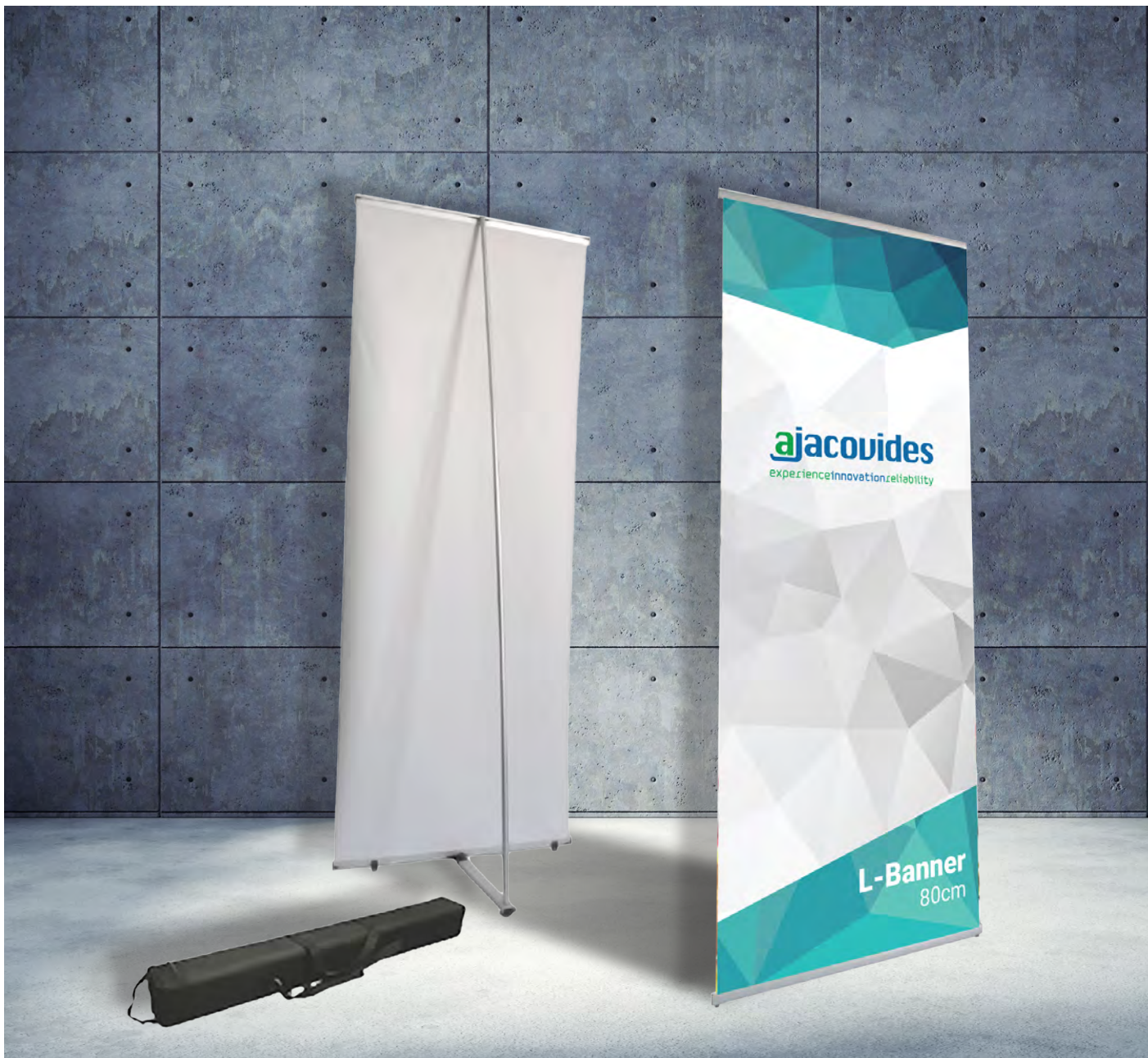



L-BANNER STAND 80cm

One face

Code:	CY-L-D1
 Graphic Dimensions: 80 x 200cm	
 Weight:	1,8 kg





Code: DH-X-BANNER/80X180

Desc: X-BANNER 80X180CM

 Graphic Dimensions: 80 x 180cm

 **Weight:**
1 kg

Code: DH-X-BANNER/120X200

Desc: X-BANNER 120X200CM

 Graphic Dimensions: 120 x 200cm

 **Weight:**
1,3 kg





Code: DH-BT-MINUTO-A4

Desc: DESKTOP ROLL-UP A4

 Graphic Dimensions: 21 x 30cm

 **Weight:**
0,8 kg

Code: DH-BT-MINUTO-A3

Desc: DESKTOP ROLL-UP A3

 Graphic Dimensions: 29,7 x 42cm

 **Weight:**
1 kg

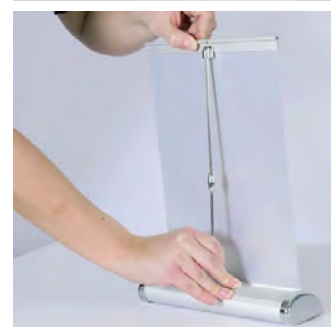



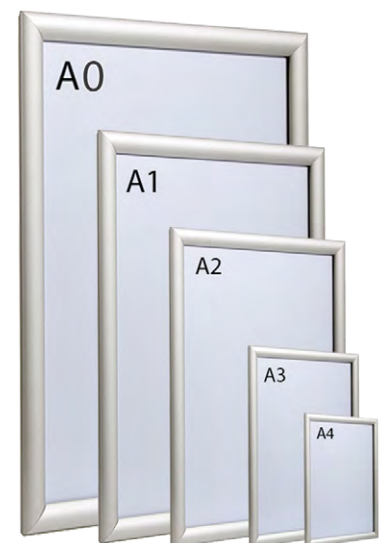

Graphic Dimensions

Code:	DH-SNAP-FRAME/A4	A4: 21 x 29,7cm
Code:	DH-SNAP-FRAME/A3	A3: 29,7 x 42cm
Code:	DH-SNAP-FRAME/A2	A2: 42 x 59,4cm
Code:	DH-SNAP-FRAME/A1	A1: 59,4 x 84,1cm
Code:	DH-SNAP-FRAME/A0	A0: 84,1 x 118,9cm
		Frame width: 25mm







Promotion Table

Code:	DH-PROMOTIONAL-TABLE-ABS
	Full Graphic Dimensions: 164 x 85cm (Visible height: 79cm) Front: 82,3w, Sides: 40,8cm. Top header: 77 x 28cm
	Weight: 9 kg
	Bag dimensions: 88 x 11 x 88cm

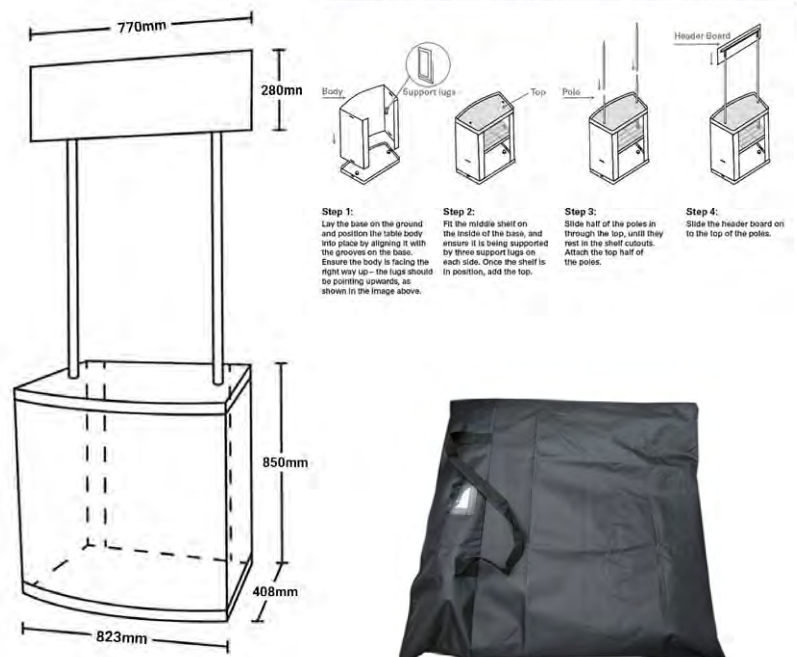
Retail Demonstrator Assembly Instructions





Code:	DH-FT-CATALOGUE
Desc:	CATALOGUE STAND A4
	Graphic Dimensions: 21 x 30cm
	Weight: 0,8 kg

- Fully Collapsible
- Tool Free Assembly
- Travel Friendly





**SUZHOU A4 CLASSIC POSTER STAND
(silver base)**



**SUZHOU A4 STANDARD POSTER STAND
(black base)**

- ▶ Adjustable height total 150cm.
- ▶ Snap frame can rotate Landscape or portrait.
- ▶ Snap frame can rotate at any angle
- ▶ Snap click frame for changing poster easily.

Code:	SUZHOU-JH4-2
	Graphic Dimensions: A4
	Weight: 3,5 kg

Code:	SUZHOU-JH4-1
	Graphic Dimensions: A4
	Weight: 3,5 kg





Code:	DH-AL-D204/A1
Desc:	A BOARD A1 (A STAND) 60X85 CM
	Graphic Size : A1 (597*841mm)
	Weight: 7,6 kg



Two face



Code:	DH-WATER-TANK-SNAP-FRAME-A1
Desc:	WATER TANK SNAP FRAME A1
	Graphic Size : A1 (597*841mm)
	Weight: 12,5 kg



Two face
Fill plastic tank with water





MAGNETIC POP UP 4*3

Type: STRAIGHT 4x3

Graphic Materials for printing:
Self adhesive vinyl + lamination matt mounting
on 6 pvc panels included.

1 Hard case rolling bag included

Code:	DH-ECONOMY-POP-UP/4*3
Desc:	MAGNETIC POP UP 4*3
	Full Graphic dimensions: 4278mm x 2230mm
	Weight: 28 kg

Code:	DH-MAGNETIC-STRIP
Desc:	MAGNETIC-STRIP FOR POP-UP

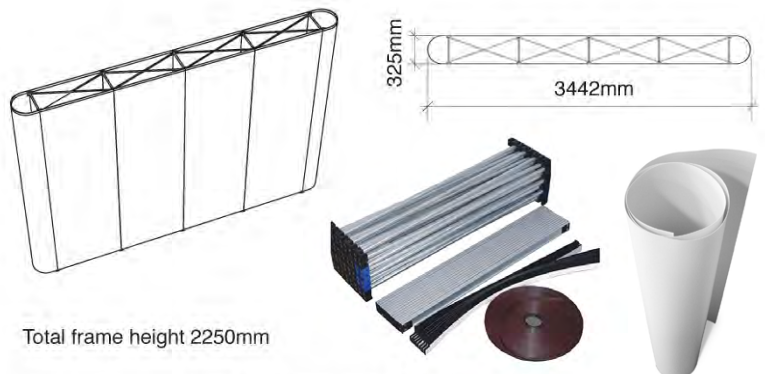



Total frame height 2250mm

Graphic dimensions 4278mm (w) X 2230mm (h)

(w) 673mm	(w) 733mm	(w) 733mm	(w) 733mm	(w) 733mm	(w) 673mm
x (h) 2230mm	x (h) 2230mm	x (h) 2230mm	x (h) 2230mm	x (h) 2230mm	x (h) 2230mm

N.B. End caps are curved
- remember to put anything
important (i.e. logos) in the half
nearest the viewer



Code:	DH-DISPLAY-COUNTER-1
Desc:	TEXTILE POP-UP DISPLAY COUNTER 95X92CM
	Graphic Dimensions: 95 x 207.5cm
	Weight: 10,5 kg

- Easy Setup Counter
- MDF Solid Counter Top & Bottom
- Easy to Transport & Store
- Printed SEG Graphics
- Padded Canvas Bag included

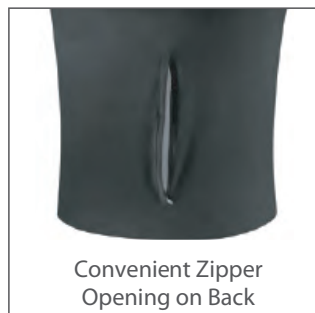







Code:	DH-BT-SNELLO-36
Desc:	TEXTILE BACK DROP 91x228cm
	Graphic Dimensions: 91 x 228cm
	Weight: 7,7 kg

Code:	DH-BT-SNELLO-60
Desc:	TEXTILE BACK DROP 152x228cm
	Graphic Dimensions: 152 x 228cm
	Weight: 11,8 kg





Code:	DH-BT-POSA
Desc:	TEXTILE BACK DROP 91x240cm with carry bag
	Graphic Dimensions: 94 x 240cm
	Weight: 5 kg

Code:	DH-BT-SERPE
Desc:	TEXTILE BACK DROP 94x352cm with carry bag
	Graphic Dimensions: 94 x 352cm
	Weight: 5 kg



RETTO-10T



Code: BT-RETTO-10T

Desc: TEXTILE BACK DROP 295x228cm with carry bag WITH WHEELS



Graphic Dimensions: 295x228cm



Weight:
15,8 kg

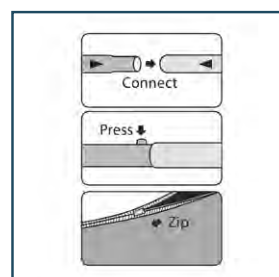



Code: DH-BT-CONCAVO-10T

Desc: TEXTILE BACK DROP CURVED 312x228cm Bag with Wheels

 Graphic Dimensions: 312x228cm

 Weight: 9,5 kg

BT-Concavo
Instructions



1. Concavo gray hard case



2. Take out the parts of the frame from the bag



3. Assemble the frame by connecting the tubes with the same mark/shape



4. Completed Concavo frame





5. To install the graphic, slide the graphic on the frame from left to right until covered.



6. Once the frame is fully covered, zip the end of the graphic.



Code:	DH-BT-FONDALE
Desc:	BANNER BACKDROP (150-300W x 1.05-2.4H)
	Graphic Dimensions: from 105h x 244cm to 152h x 300cm
	Weight: 14 kg

Code:	DH-BT-FONDALE-ACCESSORY
Desc:	BANNER BACK DROP ACCESSORY (EXTENSION UP TO 60CM)



Συναρμολογούμενο LED BACKLIT STAND με βαλίτσα!



Code: DH-LUCID/100*200CM

Desc: PVC BACKLIT TEXTILE FRAME 100*200CM

Graphic Dimensions: 100 x 200cm+2,5cm bleed

Weight:
8,7 kg

Code: DH-LUCID/100*200CM/BLACK

Desc: ABS BACKLIT TEXTILE FRAME 100*200CM BLACK

INCLUDES:
Canvas Bag with Wheels
Dimensions: 132 x 33 x 20cm

The Lucid line of backlit SEG displays are lightweight, inexpensive and extremely versatile. Lucid backlit displays feature UL certified LED lighting that's built into the frame so there's no visible wiring, and connections are made automatically when the frame sections are fit together.

The frame itself is made of synthetic structured PVC that's flame resistant, which makes the display light weight compared to other backlit displays. The frame assembles easily without tools thanks to the snap-fit interlocking design of the frame sections, making the Lucid faster and easier to set up than any other backlit display we offer.

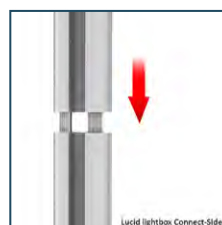
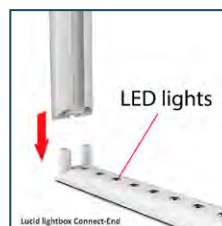

Συναρμολογούμενα LED BACKLIT STAND με βαλίτσα!

Code:	DH-LUCID/100*150CM	Desc:	PVC BACKLIT TEXTILE FRAME 100*150CM
Code:	DH-LUCID/100*150CM/BLACK	Desc:	ABS BACKLIT TEXTILE FRAME 100*150CM BLACK
Code:	DH-LUCID/152*200CM	Desc:	PVC BACKLIT TEXTILE FRAME 152*200CM
Code:	DH-LUCID/152*200CM/BLACK	Desc:	ABS BACKLIT TEXTILE FRAME 152*200CM BLACK
Code:	DH-LUCID/200*200CM	Desc:	PVC BACKLIT TEXTILE FRAME 200*200CM
Code:	DH-LUCID/300*200CM	Desc:	PVC BACKLIT TEXTILE FRAME 300*200CM

Single or Double Sided Graphic Display Capabilities

A new & cleverly designed modular backlit lightbox display system featuring high-quality fabric graphic printing, a durable & lightweight structured PVC frame, no-tool fast setup & an integrated LED light system.

Great for trade shows, retail spaces, and showrooms.



STAINLESS STEEL SPACERS for Glass, Acrylic, Perspex or Plastic Sheet

Code:	YUM-13750	HOLLOW GLASS STANDOFF 12*25
Code:	YUM-13760	HOLLOW GLASS STANDOFF 16*25
Code:	YUM-13761	HOLLOW GLASS STANDOFF 16*30
Code:	YUM-13771	HOLLOW GLASS STANDOFF 19*30





Code:	DH-STEEL-TENT
Desc:	STEEL TENT 3X3 WHITE WITH CARRY BAG
Weight:	18.6 kg

***PRICE WITHOUT TEXTILE FABRIC**

Code:	DH-STEEL-TENT/(3X6)
Desc:	STEEL TENT 3X6M BLACK WITH CARRY BAG
Weight:	30.3 kg

***PRICE WITHOUT TEXTILE FABRIC**

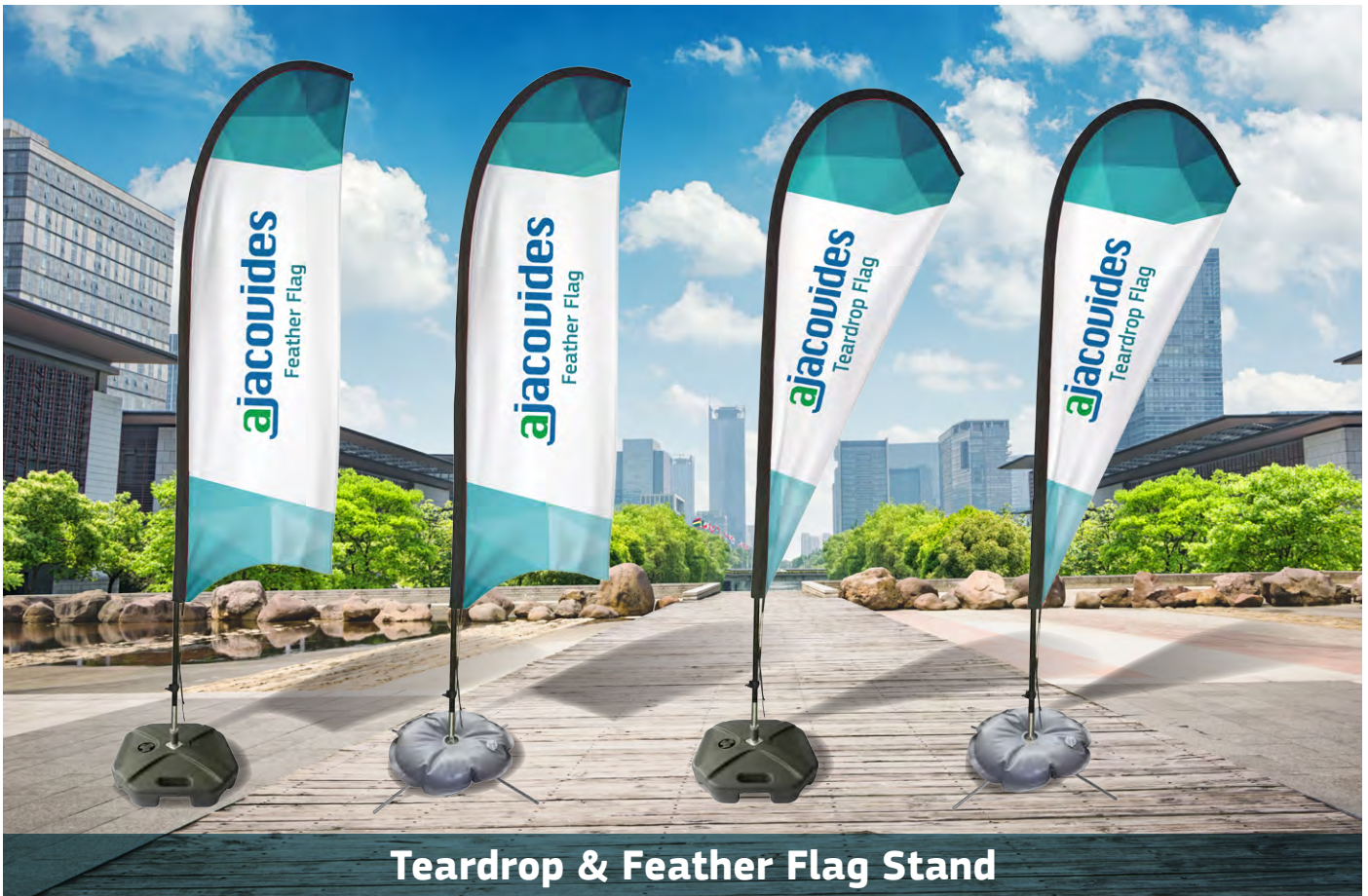

Teardrop & Feather Flag Stand



Code: MEDIUM: KAWA-CFP/M

Code: LARGE: KAWA-CFP/L

Code: XLARGE: KAWA-CFP/XL

Same pole and bases for both types



Code: KAWA-WB

Water base Standard for flag pole.

Fill: 20L

Dimensions: 50 X 50cm



Code: KAWA-ECO/W/BAG

Eco Water round for flag pole.

Fill:15L



Code: KAWA-CB

Cross base for flag pole.

Weight: 3,2kg

Dimensions: 38 x 38cm



Code: KAWA-BF

Black flag sleeve

Dimensions: 90 Running meters

Roll

Size information:

Feather Flag	Size	Flag size	Height (after flag on it)
	M	255*75cm	3.00m
	L	356*75cm	4.00m
	XL	457*75cm	5.00m
Teardrop Flag			
	M	220*75cm	2.68m
	L	310*105cm	3.60m
	XL	403*111cm	4.55m
Block Flag			
	M	166*70cm	2.15m
	L	266*70cm	3.15m
	XL	366*70c	4.15m

Code: KAWA-LARM

LARM FOR FLYING BANNER

Tip Rod
Replace tip rod by an aluminum top L arm



Block Flag



Code:

KAWA-RSPS

ROUND STRAIGHT SPIKE STANDARD

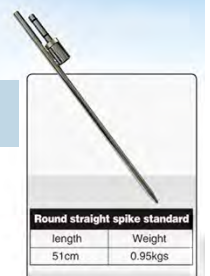

Round straight spiko standard	
length	Weight
51cm	0.95kgs

Code:	RR-1206.1281.000
Desc:	BEACH FLAG ELASTIC STRONG - 128MM - ROLL 50M - WHITE
	1206 BEACHFLAG ELASTIC Material: Polyester / latex Length: Roll 50 meters Applications: Beachflags / Drop flags Width : 128mm Colour : White

Code:	RR-1206.1281.999
Desc:	BEACH FLAG ELASTIC STRONG - 128MM - ROLL 50M - BLACK
	1206 BEACHFLAG ELASTIC Material: Polyester / latex Length: Roll 50 meters Applications: Beachflags / Drop flags Width : 128mm Colour : Black

Code:	RR-2218.0701.0000
Desc:	Header flag tape with folding stripe polyester - 70mm - roll100m - white
	2218 HEADER FLAG TAPE Material: Polyester Length: Roll 100 meters Applications: Flags and banners Widths: 70mm Colour : White

Code:	RR-4813.0251.000
Desc:	REINFORMENT TAPE POLYESTER WHITE 25mmx50m
	4813 REINFORCEMENT WEBBING Material: Polyester Length: Roll 50 meters Applications: Universal reinforcement webbing Width : 25mm Colours: White

Code:	RR-5521.1801.999
Desc:	BUNGEE LOOP WITH BLACK HOOK 18CM - 6MM (BAG25PCS)
	5521 BUNGEE LOOP WITH HOOK TENSION 25 KG Material: Polypropylene / latex / metal (plasticized) Length: Bag 25 pieces Applications: For tensioning of canvases Widths: 6 mm, Loop 18 cm Colours: Black

Commercial Graphics & HP Large format printers

ajacovides
experience innovation reliability

Printable, Decorative, Reflective, Solar, Safety Films | Large Format Printers | Signage CNC Routers
Acrylic, Pvc, Foam Sheets | Signage systems

Architectural & Interior Design

ajacovides
experience innovation reliability

Building Materials • Aluminium Composite panels • Pvc Composite Sheets
• Acrylic Sheets • Multi & Solid Polycarbonate Sheets

Powder Coatings

ajacovides
experience innovation reliability

Powder Coating for all metallic crations: • Windows & doors • Facades, curtain walling & metal shells
• Sunshades & shutters • Fencing, railings & handrails • Ceiling tiles • Garage doors
• Verandas, winter gardens, greenhouses & conservatories

**Sun Control Films
Safety & Security Films**

ajacovides
experience innovation reliability

3M
Authorized Distributor
Industrial Products

Personal Safety Equipment

ajacovides
experience innovation reliability

Προστασία αναπνοής, ακοής, όρασης, κεφαλής
Μόδες προστασίας για όλους τους επαγγελματίες
Ζώνες προστασίας | Φωσφορούχα γιλέκα, στολές | Μόδες συγκολλητών

3M
Authorized Distributor
Industrial Products

Display Stands

ajacovides
experience innovation reliability

Roll-up • X-banner • Pop up Magnetic Spider • Promotion Table • Wall snap frame
A board snap frame • Brochure holder • Teardrop & Feather Flag

Aluminium Sign Systems

ajacovides
experience innovation reliability

Textile Aluminium frames Indoor | Wall Banner frames | Acrylic outdoor frames | Info System
Bannerbox outdoor | Clip frames | Pylon outdoor signs | Readymade Panel & Magnetic Led Frames

Led Lighting & Power Supply

ajacovides
experience innovation reliability

Led strips | Led modules | Power supply | Transformers | KNX | Illuminated Led sign Systems
Neon Flex

Traffic Safety & Signage

ajacovides
experience innovation reliability

Traffic Signs | Street name signs | Cones | Bollards | Barriers | Speed Reducer
Road Studs | Solar Warning Lamps | Mirrors | Solar Cat Eyes | Directional Led Panel
Led Traffic Light | Warning Trailer | Pedestrian Safe System | Road Marking Paints

Glass Machinery & Applications

ajacovides
experience innovation reliability

Glazing Machinery | Tables for floating and laminated glass cutting | Φοινοποι Laminated / tempered
Aluminium spacers for glass

Chemicals & Activated carbon

ajacovides
experience innovation reliability

Wide range of industry-leading activated carbon solutions, serving the transportation, infrastructure,
pharmaceutical and environmental industry in Cyprus.

Medical Procurement

ajacovides
experience innovation reliability

Laryngectomy care products
Atos Medicals product series refer to a broad product range of voice and pulmonary rehabilitation
devices consisted in voice prosthesis, HME and speaking valves, adhesives and supplemental
accessories for Stoma covers.

Display Stands



Andreas Jacovides Trading Ltd

+357 22 866300 | Fax: +357 22 454843

sales@ajacovides.com

9 Imvrou, Industrial Area of Latsia | 2234 Nicosia, Cyprus | P.O.Box 17047, 2260 Latsia | Nicosia, Cyprus

A. Jacovides Trading Ltd ajacovidestrading Andreas Jacovides Trading Ltd

2023

